

The Mercedes-Maybach S-Class.



MAYBACH



That special aura. Outside and in. The new Mercedes-Maybach S-Class.

The imposing radiator grille serves as a figurehead announcing the strong presence of the Mercedes-Maybach S-Class. The legendary name shines resplendently in the grille. The elegant side view with chrome highlights on the B-pillar and the chrome-trimmed bumpers emphasize the distinct character of the Mercedes-Maybach S-Class. The triangular side windows are a typical example of the loving attention to detail. The wheels are exquisite gems. Three wheel designs have been evolved exclusively for the new Mercedes-Maybach S-Class. The Maybach forged wheels with 10-hole trim, for example.



Special hallmarks
of exquisite class.





Quietly confident. The interior of the Mercedes-Maybach S-Class.

Travelling in the new Mercedes-Maybach S-Class surpasses all expectations. The feeling of space is indescribable. No other saloon in the world offers such a quiet environment in the rear. And the Chauffeur package provides for plenty of rear legroom. Enjoy the comfort of luxurious, ergonomically perfect individual seats with leg rests. If you wish to attend to business, the extended-length business console included in the optional First Class rear suite can be transformed at wish into a desk. When your work is done, the seats can be moved into a comfortable reclining position at the push of a button.

Engines.

The rule of the road today: you can't have refinement without efficient technologies. Mercedes-Benz petrol engines are therefore lighter and measure out fuel extremely precisely. In this way they bring together a sense of responsibility and commitment, without compromising on driving enjoyment – no matter what drive system you opt for.

V8 engine. Refinement, driving pleasure and responsibility – embodied by the petrol engine with 345 kW (469 hp). Thanks to twin turbocharging and intercooling, the S 560 has huge reserves of power. The engine may give off its typical, unmistakably sonorous and cultivated sound, but fuel consumption stays exceptionally low. Its 345 kW (469 hp) accelerate, the car from a standstill to 100 km/h in a mere 4.9 seconds.

V12 engine. At the summit of the engine range the V12 biturbo engine combines fast responsiveness with environmental awareness. This is how the V12 engine saves fuel – yet is generous with superlatives: 1000 Nm of torque is on tap from below 2300 rpm. Its 463 kW (630 hp) accelerate, the car from a standstill to 100 km/h in a mere 4.7 seconds.

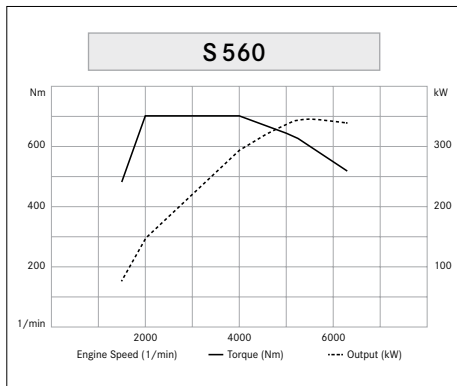

The 8-cylinder petrol engine is powerful, refined and efficient.

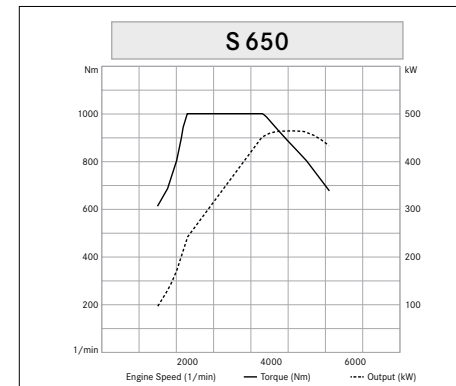

The 12-cylinder petrol engine – supreme power delivery, maximum efficiency.

*Please read the disclaimer.

Transmissions.

The consumption and efficiency-optimised 7G-TRONIC PLUS automatic transmission and the innovative 9G-TRONIC transmission stand out by virtue of their high level of efficiency, ultra-smooth gear shifting, dynamic response and reduced noise levels.

9G-TRONIC (standard for Mercedes-Maybach S 560). The 9-speed automatic transmission changes between the gears quickly and barely perceptibly, offering an extremely high level of gearshift quality. The high overall efficiency reduces fuel consumption and emissions, making an important contribution to an ecological driving style without compromising on driving enjoyment.

7G-TRONIC PLUS (standard for Mercedes-Maybach S 650). The 7-speed automatic transmission combines a high level of comfort with driving pleasure and efficiency. The 7 forward gears allow a wide ratio spread with low engine speed increments between the individual gears. This leads to fast-responding, fuel-efficient gear changes with pleasantly smooth transitions.

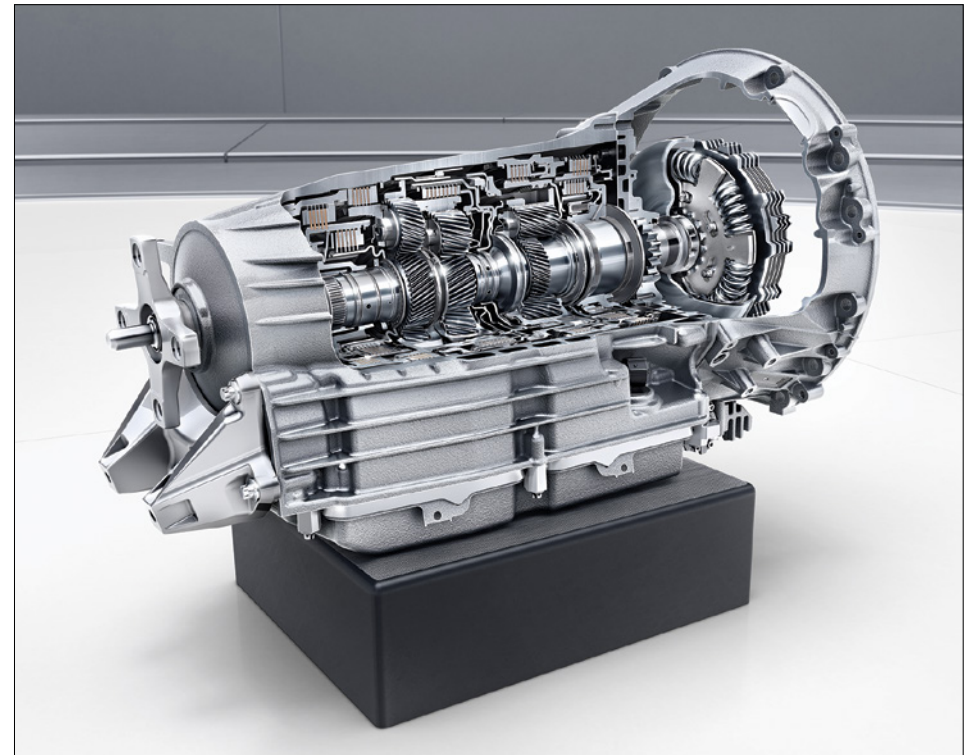
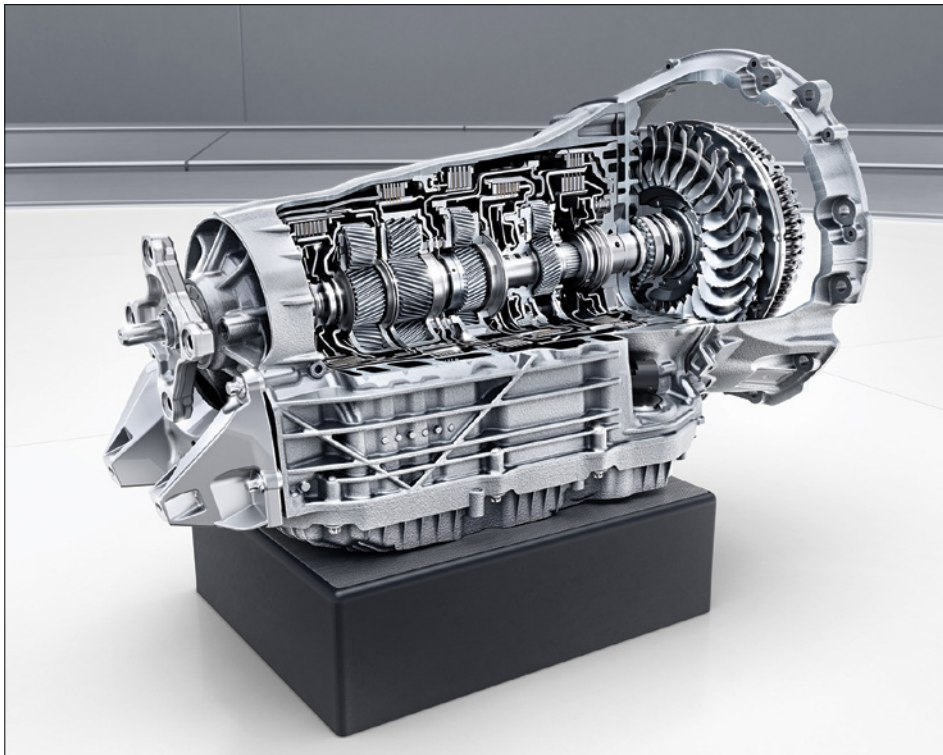

Chassis and suspension.

The Mercedes-Maybach S-Class is fitted with the latest-generation, enhanced AIRMATIC suspension system as standard. The innovative MAGIC BODY CONTROL – a technological milestone, premiered in the S-Class – is available for Mercedes-Maybach S 650.

AIRMATIC (available for Mercedes-Maybach S 560). Whether its setting is sporty or comfortable, the AIRMATIC air suspension with its continuously variable damping system adjusts the damping power at every wheel to suit the current situation and the condition of the road. The all-round self-levelling integrated into the system ensures virtually constant ground clearance, even when the car is laden, and thus more stability and comfort.

Crosswind Assist. In strong, gusty crosswinds there is a danger of the vehicle being blown off-course. Crosswind Assist is able to recognise this and help the driver to keep the vehicle on course. Using the ESP® sensor system, course-correcting brake actuation is performed automatically. This brake actuation takes place at the wheels on the side of the vehicle facing the crosswind. The resulting yawing motion around the vertical axis counters the effect of the crosswind. This reduces track offset considerably. In this way Crosswind Assist gives the driver a greater feeling of safety and helps to avoid inappropriate reactions, especially when sudden gusts strike the vehicle.

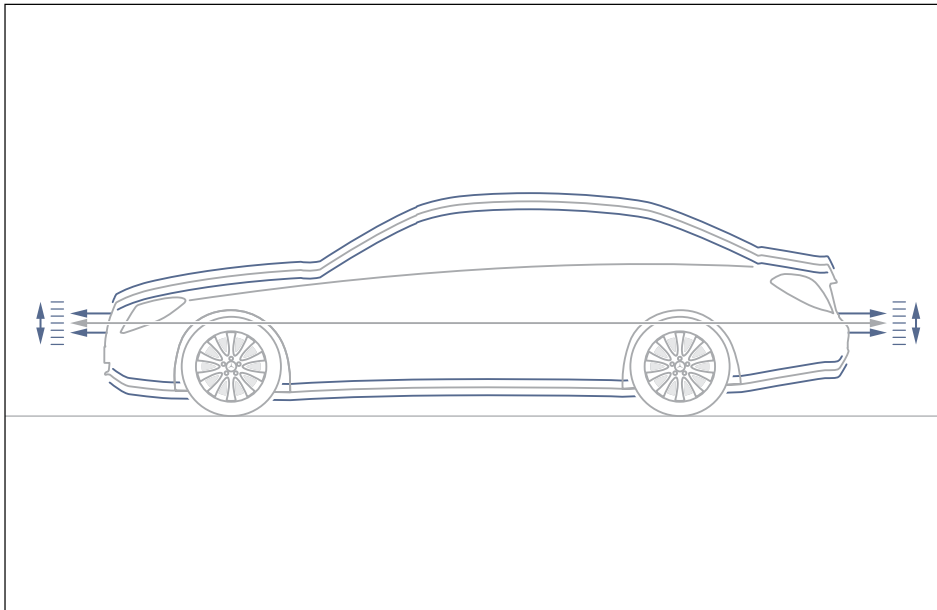

The stepless air suspension AIRMATIC with all-round self-levelling ensures excellent agility and maximum ride comfort.

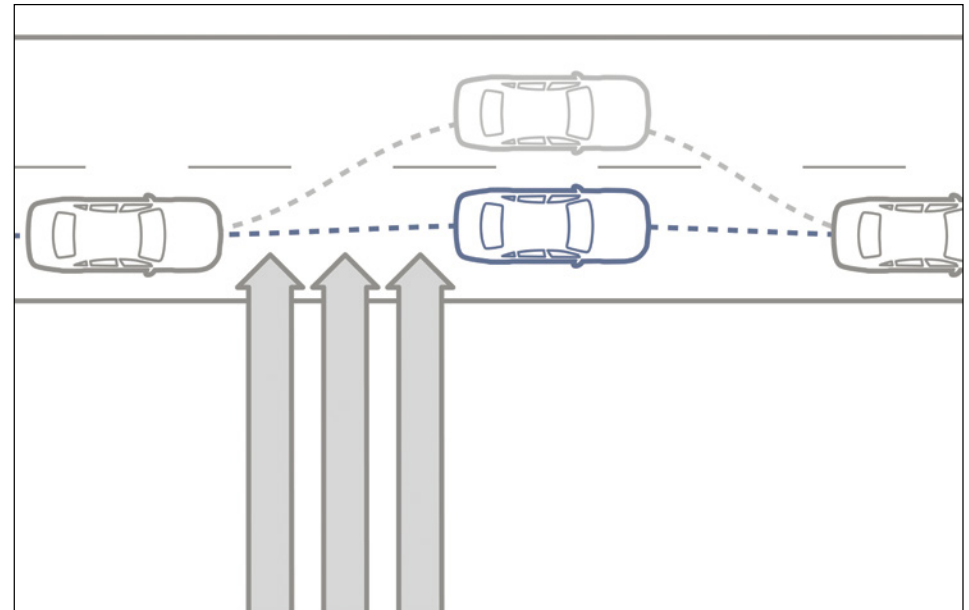

MAGIC BODY CONTROL (available for Mercedes-Maybach S 650). This active suspension effectively compensates body roll and pitching when moving off, cornering or braking. The continuously adjustable dampers allow both a comfortable basic damping action and a stiffer, speed-dependent setup. All in all this results in a combination of high comfort and thrilling driving dynamics.

Further advantages of MAGIC BODY CONTROL:

- The 'Comfort' and 'Sport' settings enable the driver to select comfortable or firmer suspension characteristics according to personal preference.
- Thanks to hydraulic all-round self-levelling, the vehicle maintains a constant level irrespective of the payload.
- The suspension level can be raised by 40 mm to increase ground clearance. At high speeds, the suspension level is automatically lowered by up to 15 mm, thereby helping to reduce aerodynamic drag and improve handling stability.
- Integrated crosswind stabilisation.



Exteriors.

MULTIBEAM LED with ULTRA RANGE Highbeam – forward-looking light technology

MULTIBEAM LED enables quick, precise adjustment of the driving lights to the current road and traffic conditions. The light can always be switched on precisely where it is required via 84 individually controllable LEDs. A total of four control units calculate the ideal light pattern 100 times per second using information from a camera behind the windscreen. The innovative technology extends and perfects the familiar functions of the Intelligent Light System.

In high-beam mode, Adaptive Highbeam Assist Plus enables continuous long-range illumination of the carriageway ahead without causing dazzle. ULTRA RANGE Highbeam increases the range of the light cone to the legally permitted maximum: If no other road user is detected, the road is straight and the vehicle speed is over 40 km/h, the additional main beam ULTRA RANGE Highbeam automatically switches itself on. The legally maximum permitted light intensity is produced, which means that the brightness of the main beam falls short of the reference value of 1 lux only at a distance of more than 650 metres. If other road users or strongly reflective traffic signs are detected by the system, ULTRA RANGE Highbeam automatically switches off and the partial main beam comes on. Only with main beam mode manually switched on is ULTRA RANGE Highbeam always active.



Interiors.

All aglow with ambient lighting.

Futuristic displays in HD resolution, select materials, a spacious feel – the **ambient lighting with 64 colours** showcases this exceptional atmosphere in the new Mercedes Maybach S-Class during night-time driving, too. For example, the indirect LED light complements the elegant lines of the trim and goes one step further: the light showcases the interior like a work of art by composing different colours to form colour schemes. This creates emotionally appealing contrasts and structures the interior in three levels. The colour scheme can be briefly replaced by special effects – for instance a Coming Home function welcomes the driver. In this way, the ambient lighting uses the positive influences of light on well-being during the journey.



Interiors.

ENERGIZING comfort control – perfectly matched programmes at the press of a button.

ENERGIZING comfort control combines various in-vehicle comfort systems into precisely defined programmes for enhanced alertness and well-being during a journey. These energise the driver in monotonous driving situations or produce targeted well-being. Included are climate control, fragrancing/ionisation, lighting mood, music/videos as well as massage, heating and ventilation of the seats. The intelligent principle: one main function dominates, while other accompanying functions reinforce the desired effect of the programme (each programme lasts 10 minutes). The programme always includes, for example, an adapted lighting mood from the ambient lighting as well as special fragrancing/ionisation from the AIR BALANCE package.

- The **“Refresh”** programme literally delivers fresh air for renewed energy on a long journey – a strong air flow

from the THERMOTRONIC (Air Pulsation) produces the greatest effect.

- If the driver or a passenger needs fresh energy for upcoming tasks, the **“Vitality”** programme comes to their assistance with activating music as the main theme. In addition, COMAND Online contains corresponding playlists with lively rhythms.
- Active instead of passive is the main theme of the **“Training”** programme, which provides animation with videos on a total of nine exercises.
- ENERGIZING massage functions with pleasant effects based on the hot-stone principle are provided courtesy of the likewise 10-minute **“Well-being”** programme. The pleasant sensation is rounded off by seat heating. This feature is optionally available for S 650.



Interiors.

Reclining seats

An automotive benchmark for peace and quiet, sleeping comfort and absolute relaxation on long journeys. The continuous, comfortable reclining surface of the Executive seat together with the electrically extending footrest provides you with a pleasant sleeping position. Control the seat backrest at the press of a button and enjoy an almost flat angle of up to 43.5 degrees.

Rear Seat Comfort package – luxury travel in the rear

The best possible seating comfort on the outer rear seats is ensured by multicontour seats, which incorporate inflatable air chambers for even more individual adjustment. The ENERGIZING massage function enhances the sense of well-being – if desired also using heat.

- Multicontour seats – perfectly adapted to the individual physique

By means of individually controllable air chambers, the multicontour seats are adjustable according to the occupant's physique. The adjustments can be made quickly and easily via the COMAND Online control and display system. This can also be done conveniently from the rear using the COMAND remote control. The seat areas that can be selected are Side bolsters of sitting surface, Seat side bolsters on the seat backrest, Backrest curvature of seat backrest in lumbar region (lumbar support) , Backrest curvature of the seat backrest in shoulder region.

- ENERGIZING massage function – relaxing, stimulating, energising

The ENERGIZING massage function has six different programs that have a relaxing, stimulating or energising effect according to personal preferences. The occupants can also choose between “low” and “high” intensity settings. The seat backrest incorporates a massage mat with 14 air chambers. These can be inflated or deflated by fast-acting solenoid valves to produce a wave-like massage effect. The inflation sequence, speed and effect vary according to the selected program. Massage duration is between 12 and 15 minutes, operation is via COMAND Online.

- With heat if required – relaxing hot-stone massage

Two of the programs have an additional warming effect modelled on the principle of hot-stone massage. This is realised by means of electronically controlled massage heating panels. Heat and gentle pressure in the spinal area make for particularly soothing relaxation. At the same time, the muscles along the spine are stimulated by gentle movements, improving blood circulation. The six ENERGIZING massage programmes include Hot Relaxing Massage for the back, Hot Relaxing Massage for shoulders, Activating massage, Classic massage, Mobilising massage and Workout etc. In cooler weather or as required, seat heating quickly brings the seat cushions and backrests of the front seats up to a pleasant temperature.



Folding tables in the rear is optionally available for S 650.

Interiors.

Climatised rear seats

Crispness on hot days – warmth on cold days. This is how the advantages of the climate-controlled rear seats can be summed up. The passengers on the outer seats in the second seat row enjoy the same pleasant seating climate as the driver and front passenger. This makes riding in the rear even more comfortable.

Seat climate control for the two outer rear seats:

- 3-stage seat ventilation with fans in seat cushion and seat back
- 3-stage seat heating with heating elements in seat cushion and seat back
- controls in the door control panels on the driver's and front passenger's side
- Time relay for the seat heating (for automatic reduction of heating output or deactivation after a predefined period)
- Seat ventilation for the outer rear seats
- Seat heating for the outer rear seats



Interiors.

Memory Package

The Memory package provides practical ease of operation – especially when your vehicle is used by different people. Besides seat adjustment, the individual position profiles also comprise the alignment of the steering column and exterior mirrors. After a change of driver or front passenger, your position can be restored at the press of a button. Set, store, recall: the driver and front passenger can each store their individual settings in one of a total of three memory presets. The memory programming includes all seat adjustment options such as seat height and fore-and-aft position, seat cushion and seat backrest angles and also head restraint height alignment.



Interiors.

Exclusive package

Enjoy a fantastic atmosphere with the Exclusive package. Almost all surfaces are finished in exquisite nappa leather: for example the upper dashboard, the seats in a diamond design or the centre armrests in the front and rear. This exceptional high-class appeal is perfectly supplemented with additional trim elements, such as in the door centre panels.

- Seat covers in exclusive nappa leather with contrasting topstitching
- Seat upholstery layout with diamond design
- Centre armrest front and rear, upper part of dashboard, door centre panels and grab handles in nappa leather with contrasting topstitching
- Upper part of dashboard and door centre panels additionally in a diamond design
- Roof liner and sun visors in DINAMICA microfibre
- Exclusive Trim package (additional trim in the door centre panels, covers of the rear air vents and on the backs of the front seat backrests)
- Illuminated door sill panels with “Mercedes-Benz” lettering
- Stainless-steel boot sill
- Map pockets on the backrests of the driver and front passenger seats in nappa leather
- designo floor mats with edging in artificial leather and designo badges



Interiors.

Rear Seat Entertainment System - First-class entertainment in the second row

Films on Blu-ray or DVD, TV, internet, video games, music – the Individual Entertainment System gives passengers in the rear their very personal entertainment program. In combination with high-quality wireless headsets (optional), two 25.9 cm (10.2-inch) displays on the front seat backrests ensure brilliant picture and sound quality. The system is conveniently operated using the COMAND remote control. It includes a Blu-ray player, is connected to COMAND Online and also has ports for connecting external devices. The passengers are independently able to access the entertainment source of their choice. Via connections in the rear armrest, content from Mp3 players, games consoles, USB sticks, iPod® or iPad® is also available.

Chauffeur package – more space in the rear

Thanks to additional fore/aft and height adjustment, the front passenger seat can be moved up to 77 mm further forward into the so-called Chauffeur position. This enables the passenger seated behind it to enjoy the journey even more. The noticeably larger legroom in the rear allows a more comfortable resting position. This is assisted by an electrically extending footrest on the front passenger side. The EASY ADJUST luxury head restraints included in the Chauffeur package offer driver and front passenger considerably more comfort and safety. The distance between the head and the head restraint is electrically adjustable, and automatically adapts to any seat adjustments, so as to maintain an optimal distance between the head and the head restraint. In addition, the side bolsters provide comfortable lateral support. On the front passenger side the EASY ADJUST luxury head restraint can be folded down or removed completely. In both cases the rear seat occupant behind it has improved visibility to the front.



Interiors.

Multifunction steering wheel in wood/leather

The combination of high-quality nappa leather in the grip area and fine wood inserts at the top and bottom make the multifunction steering wheel a highlight in terms of look & feel.

Key features of the steering wheels:

- 3-spoke multifunction steering wheel in nappa leather with two control stalks.
- Control panels on left and right with Touch Control buttons, on the right for operating the instrument cluster, and on the left for operating the multimedia system – audible feedback via the vehicle's loudspeakers.
- On the right there are also additional controls for the Active Distance Assist DISTRONIC or cruise control and speed limiter.
- DIRECT SELECT steering wheel gearshift paddles on the back of the horizontal steering wheel spokes.
- Differentiation of the steering wheel variants based on the chosen design and equipment line.



Interiors.

THERMOTRONIC automatic climate control

The THERMOTRONIC controls the individual temperature in two zones. You and your front passenger can thus set your preferred climate independently of one another. And you never have to readjust. Because the sensitive sensors even register changes in conditions, such as sunlight. The activated charcoal particle filter also works very efficiently, and as well as particulate matter it eliminates harmful substances and unpleasant odours.

Individually adjustable climate comfort for passengers in the rear too: this equipment expands the THERMOTRONIC automatic climate control system to four zones. Temperature and ventilation intensity can be controlled separately for four zones – providing all passengers with their desired feel-good climate.



Interiors.

AIR BALANCE package – personal fragrance and clean, fresh air

The vehicle interior can be fragranced to suit personal preference with the AIR BALANCE package. There is a choice of six high-quality interior fragrances according to personal preference. In addition, the air quality can be improved by ionisation and optimised filtering of the incoming and recirculating air.

The six fragrances for the AIR BALANCE package:

- FREESIDE MOOD
- PACIFIC MOOD
- AGARWOOD MOOD
- NIGHTLIFE MOOD
- DOWNTOWN MOOD
- SPORTS MOOD
- Additional fragrance flask for filling with personal commercial fragrance

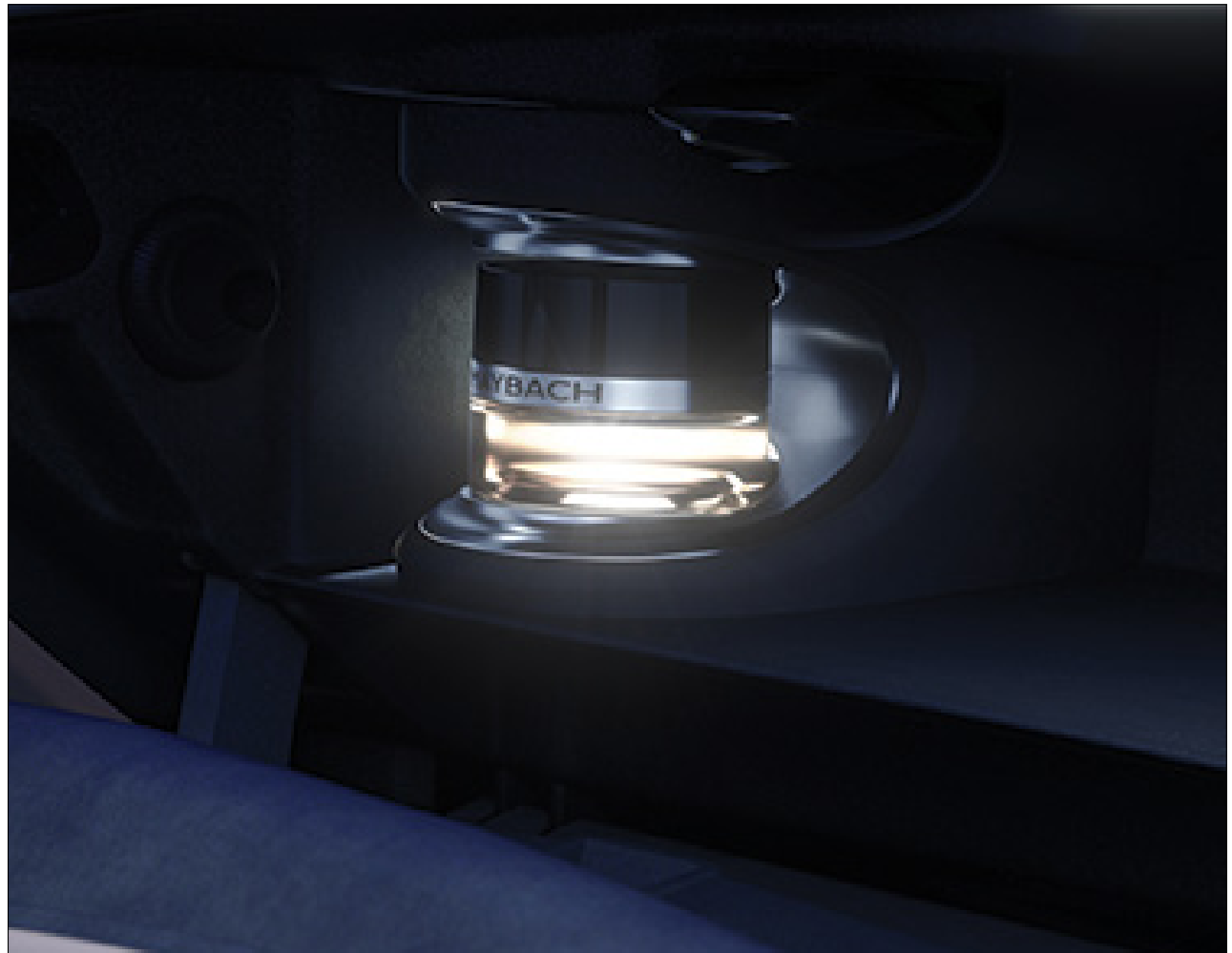

Interiors.

Burmester® high-end 3D surround sound system with 26 high performance speakers.

Burmester® high-end 3D surround sound system – innovative technology for a unique listening experience the standard-fit Frontbass system provides a breathtaking bass performance, the bodyshell structure is used as an exceptionally stable, low-vibration bass housing with high level stability. 28 amplifier channels with a total system output of 1590 watts and technologies developed exclusively for the vehicle optionally provide for unprecedented listening enjoyment. The combination of analogue and digital components

results in an extraordinarily expressive and fascinating 3D sound – the Burmester® “feel-good sound”. With the 3D surround sound system, passengers are able to experience and enjoy a 3D reproduction of mono, stereo and 5.1 music signals in the vehicle. This is achieved with the aid of special algorithms and three speakers integrated in the roof lining. The VIP setting makes it possible to adjust the sound individually for the driver, front passenger and passengers on the left and right in the rear. To suit personal tastes, individual sound settings can be carried out with the five sound presets “Pure”, “Easy Listening”, “Live”, “Surround” and “3D Surround”.



Interiors.

Follow a guiding hand for once: COMAND Online.

Navigation, telephone, audio, video, internet – with the **COMAND Online** control and display system the driver is able to keep tabs on these and many other functions. Information is shown in colour on a 31.2 cm high-resolution media display. Fast hard-disc navigation with realistic topographical map display for relaxed route guidance. Other highlights of COMAND Online include the Bluetooth® interface with hands-free function and telephony via wideband speech, a read/write function for text messages and emails and music transmission via audio-streaming.

Touchpad with Controller.

The control elements for the multimedia system are located in the centre console: the touchpad, Controller and direct-access keys are ergonomically arranged. The touch-sensitive touchpad is of high-quality design and is integrated into the handrest for the Controller. It responds to one and two-finger gestures: swiping movements are used to navigate in the menu, while spreading movements enlarge the content and inputs are confirmed by the touch of a finger. The touchpad even recognises your handwriting – i.e. letters, special characters and figures. This character recognition function enables you to enter addresses or telephone numbers very quickly.



Interiors.

Wireless charging system in the front and rear – power supply without cable or charger cradle

The wireless charging system functions with all mobile devices which support or can be upgraded to support the Qi standard. The charging surface is integrated into the quick stowage tray in the front on the centre console and accepts mobile phones with a screen diagonal of up to 15.2 cm (6 inches). A connection is quickly established between the multimedia system and mobile phones via Near Field Communication (NFC) by touching the “NFC” logo. Telephone calls are then conducted automatically via the Bluetooth® hands-free system.



Smartphone Integration - for safe and intuitive smartphone use

Smartphone Integration allows integrating iPhones® via Apple CarPlay™ as well as Android smartphones with Android Auto into the vehicle, and operating them by voice control – certain functions can also be used via the vehicle controls. This makes safe use possible while on the move. The connection to the smartphone provides access to the latest software and data such as, e.g. navigation and traffic information, media (streaming media and IP radio), as well contact information, telephony/FaceTime and messaging. To prevent driver distraction while at the wheel, not all smartphone content is duplicated.



Interiors.

EASY ADJUST luxury head restraints for driver and front passenger, folding and removable on front passenger side

The EASY ADJUST luxury head restraints have two decisive advantages. In addition to head restraint height, the optimum fore/aft distance is also electrically adjustable. This optimises both comfort as well as the protective effect in the event of a possible accident. For improved forwards visibility from the rear, the head restraint of the front passenger seat can additionally be folded down and removed.



Interiors.

Surround lighting with projection of brand logo (Available with S 560 Maestro Edition)

A function which also appeals to your emotions. That's because the surround lighting projects the brand logo using LED technology next to the opened side doors at the front and rear. This not only showcases an attractive eye-catching feature in dark surroundings. The additional light also makes it more convenient for you when getting in and out.



High-pile floor mats

The 4 deep-pile floor mats meet exclusive quality and design standards. They are finished in the respective appointments colours and blend into the interior design perfectly. In addition the mats protect the footwell against dirt – they can be removed easily to be hoovered or cleaned.



Interiors.

KEYLESS-GO

Maximum comfort for your day-to-day motoring: with the KEYLESS-GO Comfort package, you can start and lock your vehicle simply by have the key on your person.



HANDS-FREE ACCESS

Load up in a relaxed, stress-free manner with HANDS-FREE ACCESS: the boot lid features contactless opening. For this the sensor area beneath the rear bumper detects a kicking motion with your foot. This is particularly useful when you come back from shopping loaded up with heavy bags.

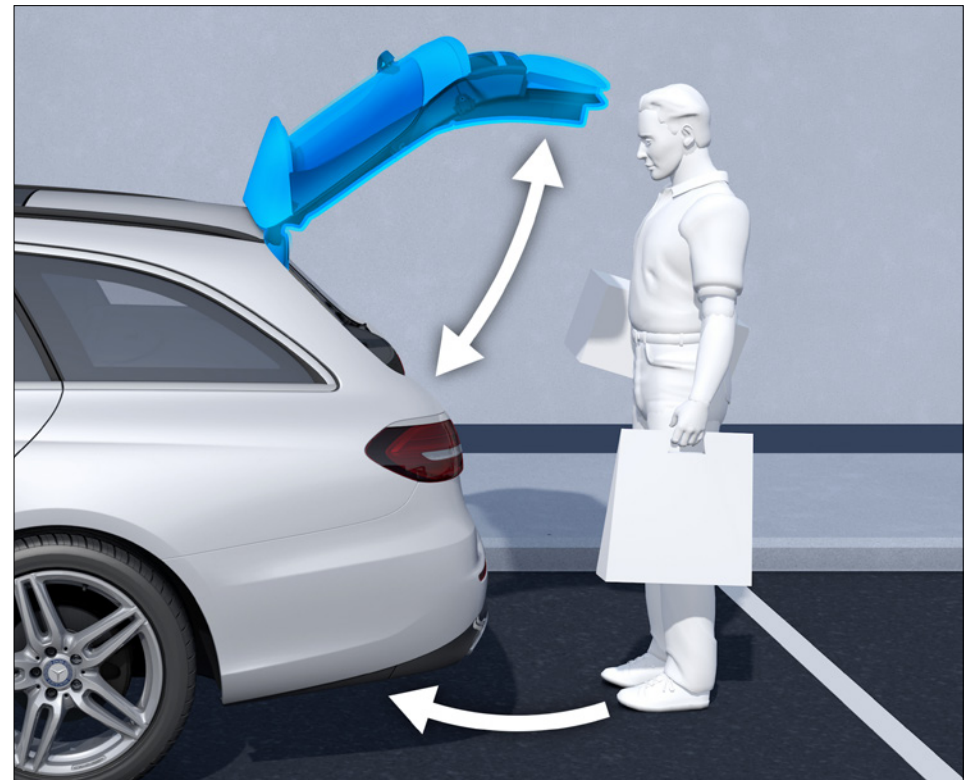

*Please read the disclaimer.

Interiors.

Exclusive trim package – stylish highlights in elegant wood

The vehicle interior can be further individualised stylishly with this exclusive package. The rear passengers in particular are able to enjoy a significantly increased level of high-class appeal as a result. This comes courtesy of a wide, curved elegant wood trim element made up of several sections, which encompasses the entire rear bench seat. In addition, the reverse of the front seat backrests is additionally finished in elegant wood trim, as are the lower areas of the doors in the front and the rear and also the covers of the rear air vents.

Features of the Exclusive trim package:

- Wood trim in the lower area of the doors in the front and the rear
- Reverse of the front seat backrests faced in wood trim (available selectively)
- Wood trim behind the rear bench seat
- Wood covers on the rear air vents

Sun Protection package

The electrically operated roller sunblinds for the rear window and rear side windows enable the passengers to shield themselves from direct sunshine and prying eyes. The view to the outside is maintained.

Sun Protection package includes:

- Electric sunblind for rear window
- Electric sunblinds in rear doors, left and right
- Switches in the rear door control panels and driver's door

Illuminated Door sill panels with “MAYBACH” lettering - Front and rear

The high-quality illuminated door sill panels with “MAYBACH” lettering indicate an exclusive character as soon as the doors are opened. They also protect the entrance area from damage.

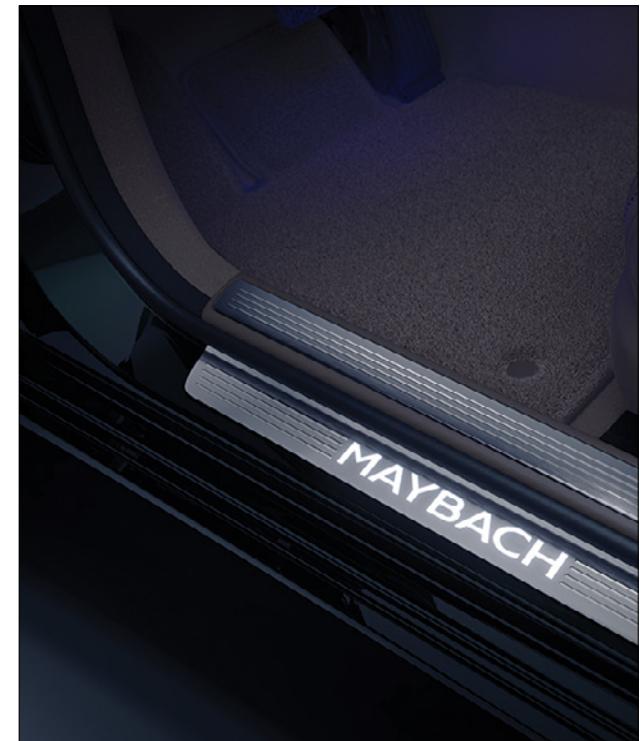

Mercedes-Maybach S 650 Optional features.

Refrigerated compartment

Cooled food and drinks always at hand – the refrigerated compartment provides this treat to passengers in the rear. It is elegantly integrated into the rear armrest and has a capacity of approx. 8.5 litres.

Champagne flutes

A drive in a quite exceptional vehicle can be celebrated in style with the two high-quality, silver-plated champagne flutes.



First-Class rear suite 2x2 seats – comfortable working environment

The continuous Business console transforms the rear into a mobile office. Two 12 V sockets and temperature-controlled cup holders make for a comfortable travelling and working environment. The Business console extends from the front centre console through to the parcel shelf. The First-Class rear suite can be further upgraded with optional features such as folding tables, Business telephony with handset or a 230 V socket.

Folding tables in the rear

With the two high-quality folding tables in the interior colour, the business console of the First-Class rear suite can be converted into an office desk in seconds. The stowage trays provide space for a notebook or documents, allowing comfortable working. The folding tables are integrated into the stowage compartment in the business console, and can be easily folded out manually once the armrest has been opened.



Accessories.

Vehicle key (Available with S 560 Maestro Edition)

High-gloss black with ornamental surround in high-gloss chrome.



2 Wireless Head Sets

A totally personalised multimedia experience – listen to your favourite song or enjoy your favourite film, without disturbing other passengers. The sets of wireless headphones featuring a high-quality finish boast high wear comfort, even when used for longer periods.



Safety and Assistance systems.

Panoramic sliding sunroof with MAGIC SKY CONTROL – (Available with S 560 Maestro Edition)

Technically sophisticated and very flexible to use. Enjoy something of an open-air ambience when the front segment is in the classic sliding sunroof position. When it remains closed, it combines with the rear section above the rear to create a large panoramic glass area. You can switch both segments to light or dark independently of each other with MAGIC SKY CONTROL.



Magic Sky control for Maybach S 650 (optionally)

Safety and Assistance systems.

Adaptive Highbeam Assist Plus

Drive with permanent main beam. This virtually turns night into day and relieves the strain on you in your driving duties. See very far, don't dazzle – the Adaptive Highbeam Assist Plus works according to this motto. The intelligent system spares oncoming traffic or vehicles in front with highly precise LEDs: you do not have to keep on changing over to low-beam headlamps.

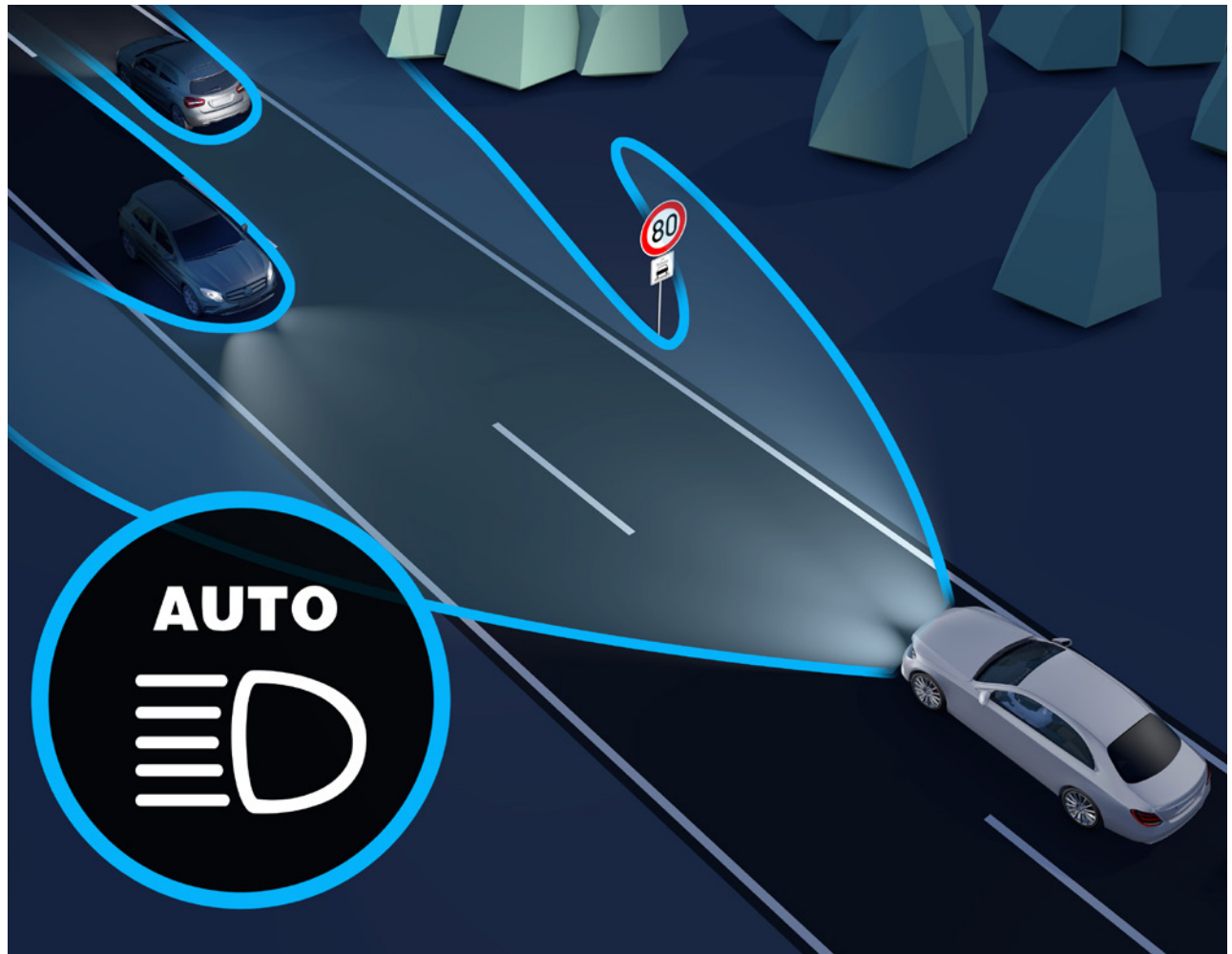

Safety and Assistance systems.

Night View Assist Plus – seeing more for safer driving at night.

Only 20% of road traffic is at night-time, but 40% of all fatal accidents occur during this period. Night View Assist Plus enables drivers to detect pedestrians or larger animals sooner in the dark. They are clearly highlighted in the Cockpit Display. To do this the system illuminates the road ahead with two anti-dazzle infrared lamps. With the help of an infrared camera located behind the windscreen, the entire area within high-beam headlamp range is shown as a crystal-clear greyscale image. A thermal imaging camera in the radiator grille is able to give a precise warning by distinguishing between irrelevant objects such as traffic sign combinations or bushes and relevant objects such as pedestrians or large animals. The latter are highlighted in colour by small “photo mounts”. The spotlight function enables endangered pedestrians to be flashed at several times, so that the driver registers them even more quickly and the former recognise the danger. As standard, the night view image only appears automatically when a hazardous situation is recognised. This feature is available optionally for S 650.

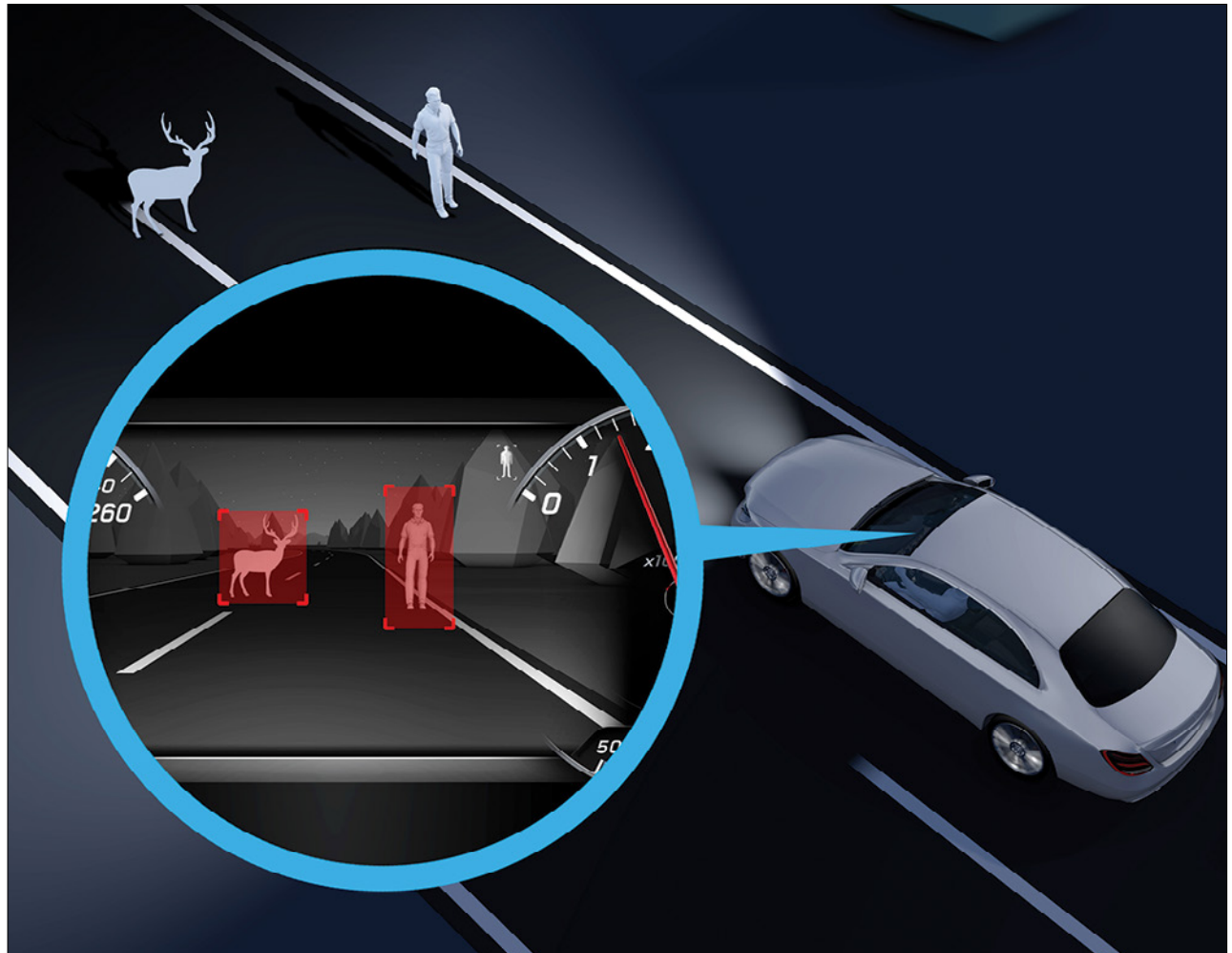

Safety and Assistance systems.

MAGIC VISION CONTROL – effective and efficient windscreen wiping (Available with S 650 optionally)

The adaptive windscreen wiper system provides the driver with the best possible visibility even during the wiping process. The washer fluid is sprayed directly in front of the wiper blades and wiped away without delay. This is done via small nozzles in a distribution rail above the wiper blade. Thanks to this precisely targeted distribution, washer fluid consumption is reduced by up to 50%. When operating while the panoramic sliding sunroof is open, the amount of washer fluid is actively reduced to avoid spraying the interior.

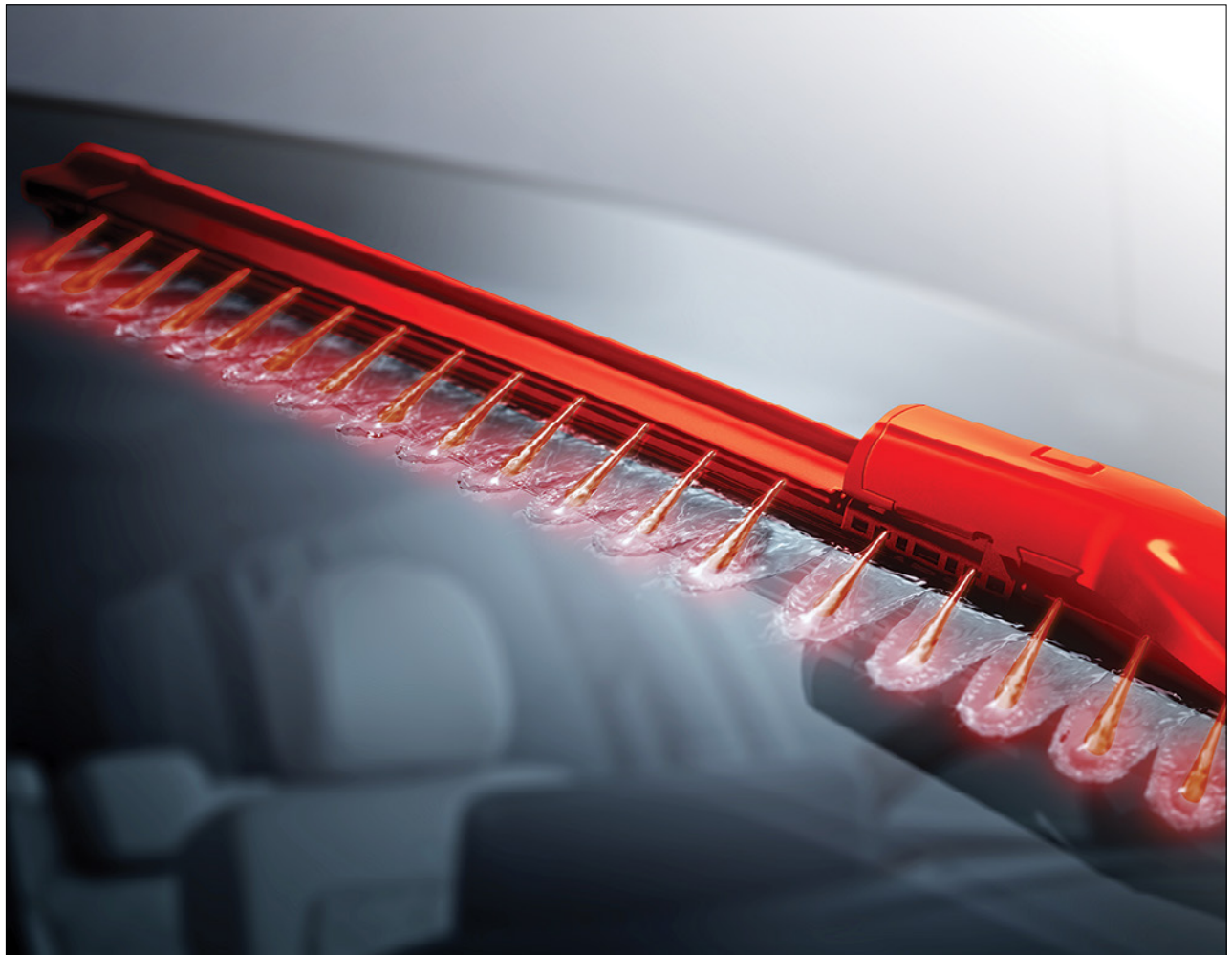

Safety and Assistance systems.

Driving Assistance package – more stress relief, more safety, more protection

Assisted driving on motorways, country roads and even in town, assisted situation-dependent braking in critical situations when needed, and active assistance during evasive manoeuvres – these are just some of the functions of the Driving Assistance package. The aim: more comfort and less stress by relieving the driver’s workload, thereby improving safety for all road users.

Active Distance Assist DISTRONIC and Active Steering Assist

Active Distance Assist DISTRONIC controls the distance to vehicles in front up to a speed of 210 km/h and if necessary brakes the vehicle with up to 50% of the maximum braking power. At speeds up to 210 km/h, Active Steering Assist helps the driver keep the vehicle in the centre of its lane on straight stretches of road or slight bends. Up to 130 km/h the system also uses vehicles travelling in front for orientation.

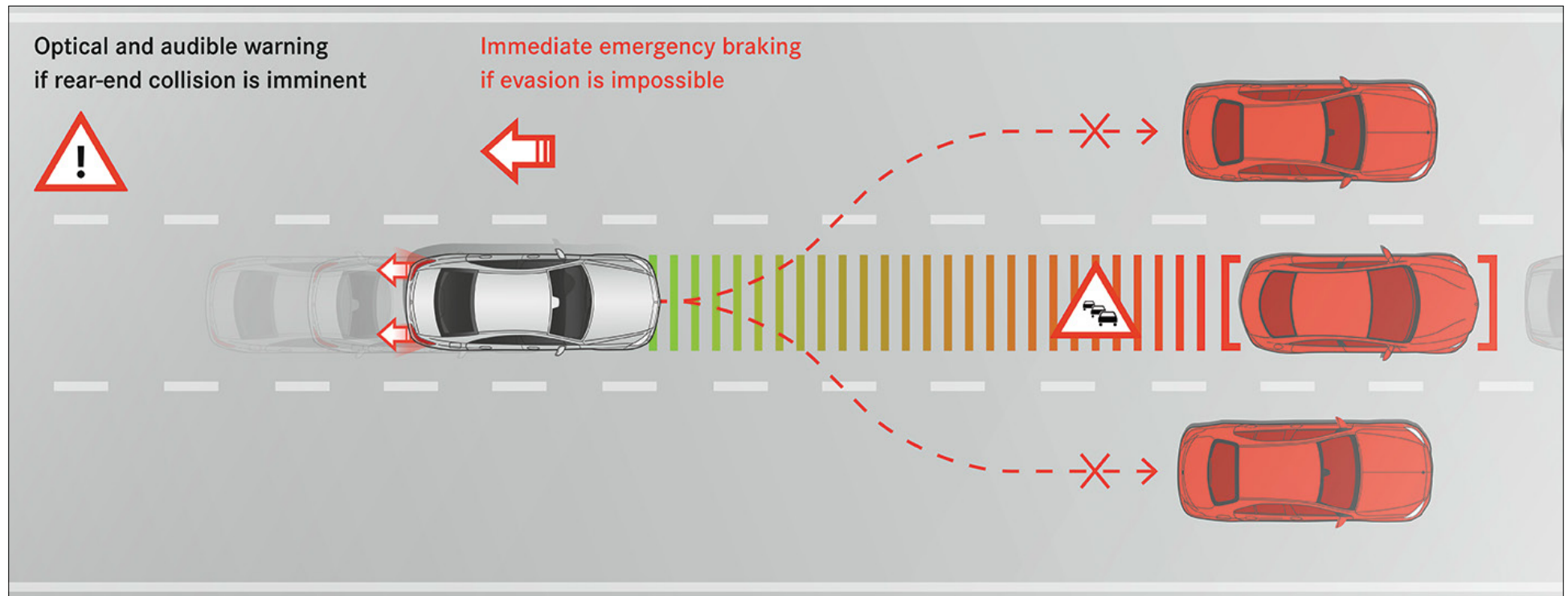

Safety and Assistance systems.

Active Braking Assist

If an accident risk is detected, the system can warn the driver, assist with emergency braking and, in an emergency, apply the brakes automatically. It can detect slower-moving, stopping and stationary vehicles as well as crossing traffic at junctions, vehicles at the end of a tailback and pedestrians in the danger zone with the aid of radar sensors and the stereo camera. If danger is detected, the system gives the driver a visual and audible warning. If the driver reacts and brakes, it can boost the braking effect as the situation demands if required, right up to full brake application. If the driver fails to respond, Active Braking Assist is able to brake the vehicle in accordance with the situation. At the end of a tailback, if the system is not able to detect any options for evasive manoeuvres, the Congestion emergency braking function can reduce the speed automatically. Up to a speed of approx. 100 km/h this can contribute to preventing an accident, or up to a speed of approx. 130 km/h it can at least mitigate the severity of the accident – all within the respective.

Active Blind Spot Assist

Active Blind Spot Assist can warn the driver of vehicles in the blind spot during a lane change and can help to avoid a collision by means of one-sided brake applications.

Active Lane Keeping Assist and Active Blind Spot Assist

provide support when the car unintentionally leaves its lane or if there is a risk of a collision with other vehicles when changing lanes. One-sided brake actuation can help return the vehicle to its lane and ideally prevent an accident.

Active Blind Spot Assist is able to assist the driver in carrying out lane changes in a particularly safe manner – in the city, on multi-lane highways and on motorways. In city traffic, cyclists can also be detected.

Active Parking Assist with PARKTRONIC

Turn the stress of tight parking spaces into effortless calm. Active Parking Assist with PARKTRONIC is not only able to find parking spaces – it also helps you to enter and leave them. As part of this it helps you with steering, and on vehicles with automatic transmission also with accelerating, braking and changing gear.



Safety and Assistance systems.

Rear Seat Safety package – more safety for rear passengers

Safety in the rear is further enhanced by the combination of sidebags plus beltbags for the outer rear seats. The central airbag control unit decides which restraint systems are to be deployed based on the available sensor data.

- Sidebags can protect the chest area in the event of a side impact

When activated, the rear sidebags provide additional protection for the chest area in the event of a heavy side impact. They supplement the standard-fit windowbags and help to further reduce the risk of injury to occupants in the outer rear seats. The sidebags are integrated into the rear side panelling and, once triggered, deploy at chest height between the side of the vehicle and the rear passenger.

- Beltbags for enhanced comfort and safety on the outer rear seats

Inflatable beltbags replace the standard belt straps on the outer rear seats. Like the standard belts, they feature pyrotechnic belt tensioners and belt force limiters. The beltbags are comfortable and have a high-quality look. When activated in the event of a heavy frontal impact, they can reduce the force exerted on the chest area by distributing it over a wider area.

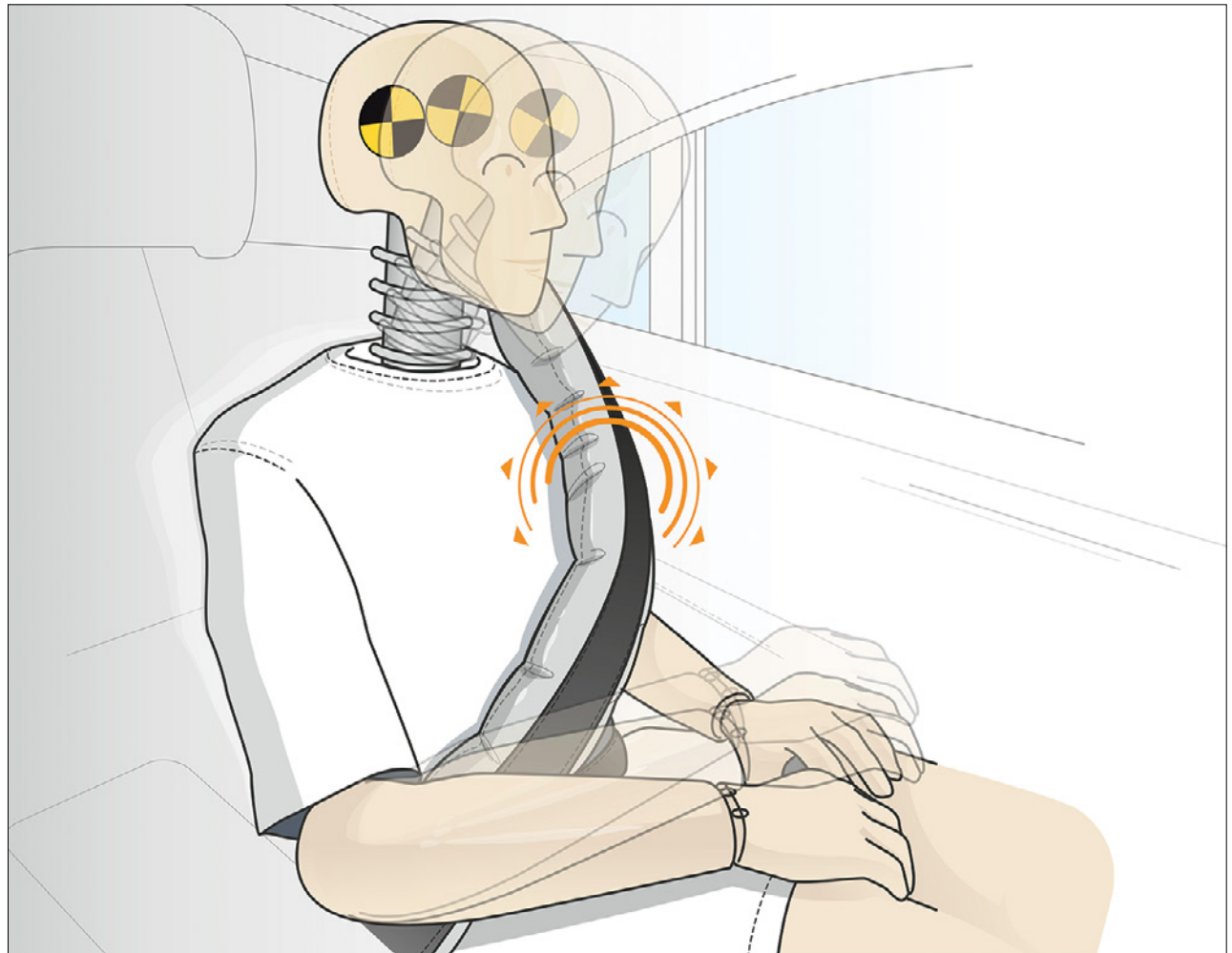

Safety and Assistance systems.

Automatic front passenger airbag deactivation

The system deactivates the front passenger airbag automatically when it detects a rear-facing child seat or registers that the front passenger seat is unoccupied. A transponder in the child seat is not required. If the system detects that an adult is occupying the seat, the airbag is automatically activated and the risk of incorrect operation reduced.



Safety and Assistance systems.

PRE-SAFE® rear package – more comfort and better protection.

Illuminated seat belt buckle extenders make seat belt fastening easier for passengers on the outer rear seats, and can tension the seat belts in critical situations to increase occupant protection. The beltbag, a type of inflatable belt strap, reduces the load exerted on the chest during a crash. When passengers enter the rear, the belt buckles extend upwards by 70 mm and light up. After the seat belt is fastened, the belt buckles return to their original position while individually adjusting the seat belt fit. If the PRE-SAFE® system recognises a critical driving situation, the belt buckles are retracted by 40 mm to tension the seat belts and fix the occupants in place as firmly as possible for a collision. If an impact occurs, the beltbag fitted with tear seams is inflated to almost three times its width. The loads acting on the occupants are distributed over a wider area, correspondingly reducing the loads on the chest area. After an accident the belt buckles light up and extend upwards to relieve the belt tension. This facilitates the rescue of the occupants.

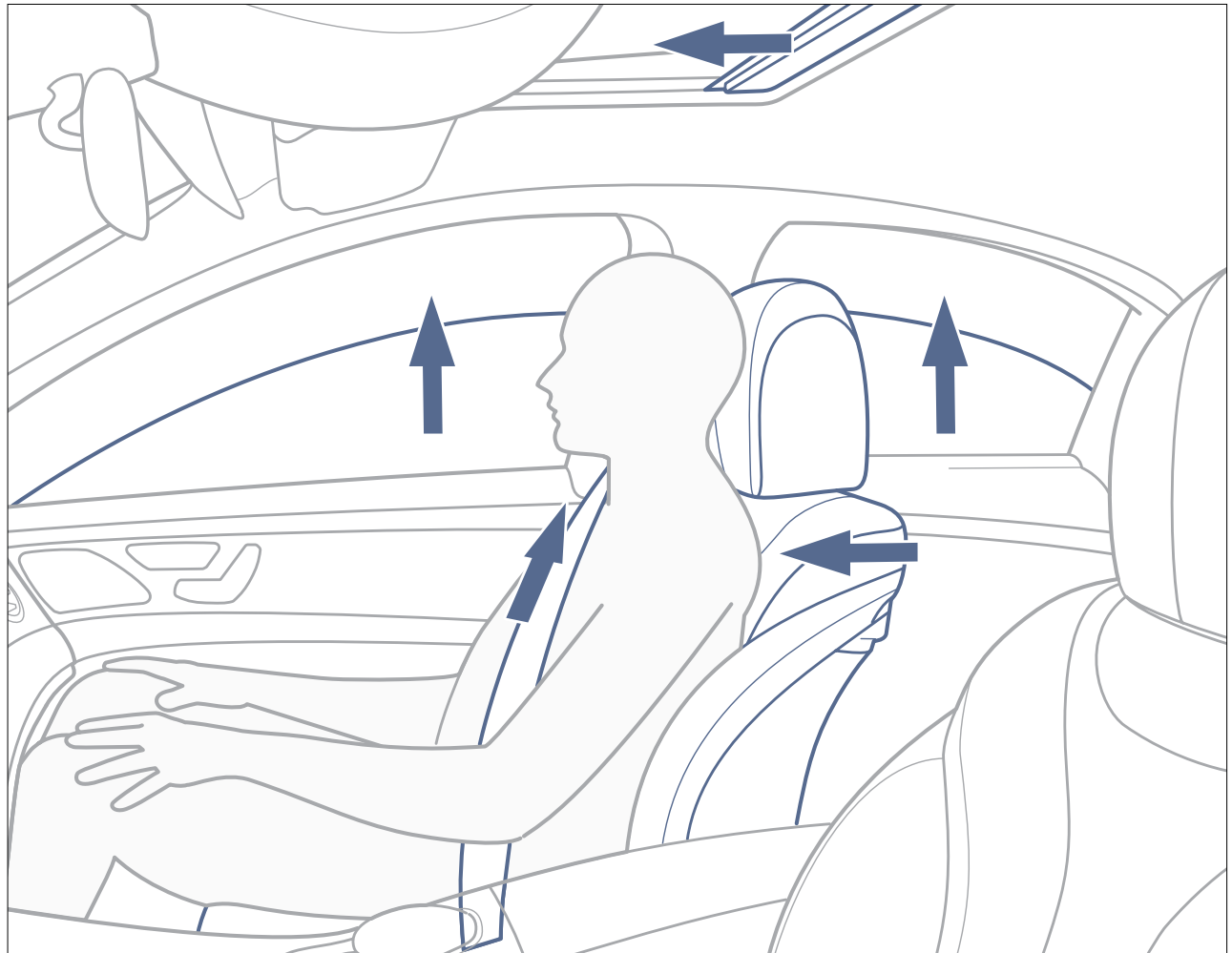

Safety and Assistance systems.

Tyre pressure monitoring system

The system monitors the tyre pressure for you and provides you with a warning in the event of a drop in pressure. This way you can react more quickly to these hazardous situations. Too low a tyre pressure can also result in longer stopping distances. When the control systems notifies you, you should top up the air quickly. Correct tyre pressure additionally increases mileage.

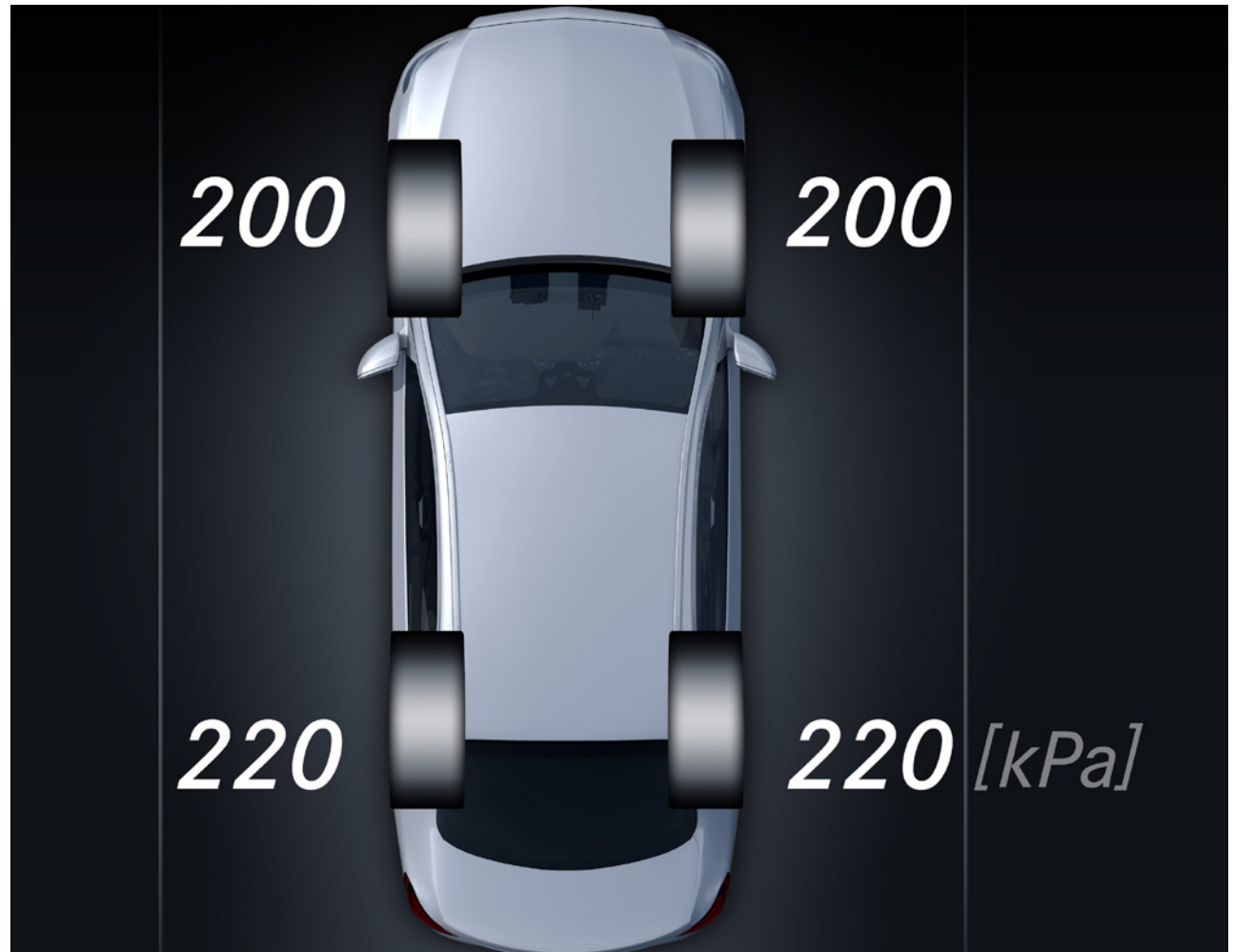

Mercedes me connect

The communications module (LTE) offers you a definite advantage in terms of convenience and safety. It provides your vehicle with a connection to the internet – allowing you to make use of helpful services from Mercedes me connect. Two mobile phone antennas and an LTE-compatible SIM card ensure a fast connection.

Let your personal digital assistant take the experience to an all new level in your everyday life.

- ✓ Stay informed. About your Mercedes-Benz and everything associated with it. Tyre pressure: okay! Fuel tank: nearly full!
- ✓ Off to new places: You can directly send any type of destinations to your vehicle from your smartphone.
- ✓ Relax on the road. Calmly complete your first conference call during your journey as the navigation system plots the ideal route to your next meeting.

All-in-one service package: Get reminders and never miss a service appointment, conveniently book your service appointment online.



Vehicle Monitoring

Always at your side: Vehicle Monitoring connects you to the car and guarantees that you always have the information you need. Thanks to a special app, you always know where your vehicle is located and can even stipulate the area in which it is permitted to be. You are also immediately informed about any undesired movements.

Parked Vehicle Locator: Unfamiliar city, winding streets – where was it you parked? Your smartphone knows the answer. It can locate your parked vehicle within a radius of 1.5 kilometres and show you on a map how to make your way back to the vehicle.

Vehicle Tracker: Perhaps a family member is driving your car and you wish to know its current whereabouts. The app knows the answer. For this purpose, your vehicle's geo-coordinates are sent by GPS.

Notification if the vehicle exceeds the set speed: Receive an alert if your vehicle exceeds a certain speed. The notification is sent directly to your smartphone by an app. This is where you can set the desired threshold value (from 0 to 255 km/h), and obtain a list showing when and where the speed was exceeded. This allows you to stay informed when someone else is using your vehicle.



Vehicle Set Up

Remote Retrieval of Vehicle Status: You have easy access at all times to the most important information about your vehicle – available from the Mercedes me App or the Mercedes me Portal. These include mileage, tyre pressure, washer fluid level, fuel tank level and also when the next service is due.

Remote Door Locking and Unlocking: We've all done it: no sooner have you left the vehicle than you suddenly can't remember whether or not you locked the doors. With the Mercedes me App or from the Mercedes me Portal, you always have certainty – and can lock the doors later if needs be. And if you ever lock yourself out, if your passengers are already waiting next to the car or if a friend needs to go back and fetch something from inside the vehicle, you can unlock the doors remotely. In this case, you receive a corresponding acknowledgement on your smartphone.

Send2Car function: Smartphone and car, more connected than ever before: found a place of interest or the best restaurant in town? You can easily send the address to your vehicle via an app. You just need to confirm the import and the data will be integrated into your navigation system.



Navigation Connectivity package

In combination with the standard-fit communication module (LTE) and the hard-disc navigation makes sure that you always reach your destination as quickly as possible by the best route. Enhanced Navigation Services can even provide you with predictive information: You are provided with optimised travel destinations and your vehicle can answer questions about your journey, such as current filling petrol station prices along the route or the parking situation at your destination.

Mercedes-Benz emergency call system

The Mercedes-Benz emergency call system can save you vital minutes in an emergency. If an accident is detected, a communications module with its own SIM card automatically triggers an emergency call which can shorten the time until the rescue services arrive. In the case of a connection with the Mercedes-Benz emergency call centre, a member of staff will support you over the voice connection until the rescue services arrive. This means that you are not left on your own in a stressful situation. Alternatively, an emergency call can be triggered manually to organise assistance.



designo customizations - Upholstery.

Please find below a number of particularly harmonious examples from our countless upholstery and trim combinations. If your own personal choice is missing here, we will be pleased to put your ideal combination together at your authorised Mercedes-Benz dealership.

Upholstery in black

501 Exclusive nappa leather

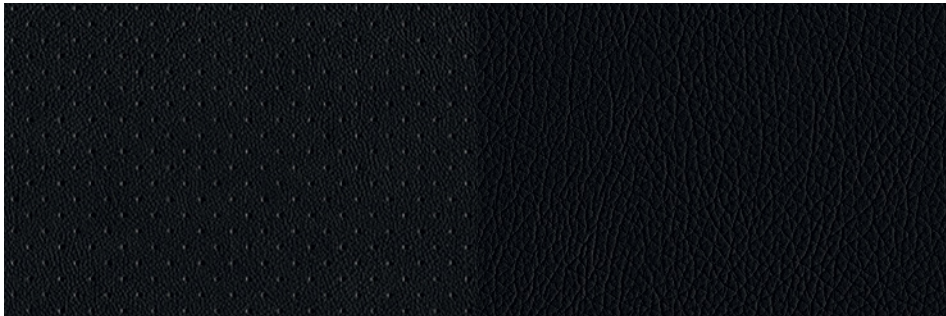

Upholstery in silk beige/espresso brown

505 Exclusive nappa leather



designo customizations - Upholstery.

Upholstery in magma grey/espresso brown

518 Exclusive nappa leather



Upholstery in silk beige/espresso brown

514 Exclusive nappa leather

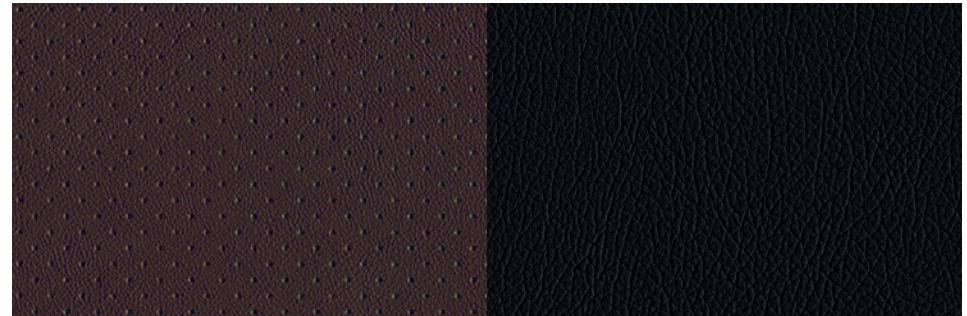

designo customizations - Upholstery.

Upholstery in porcelain/black

515 Exclusive nappa leather

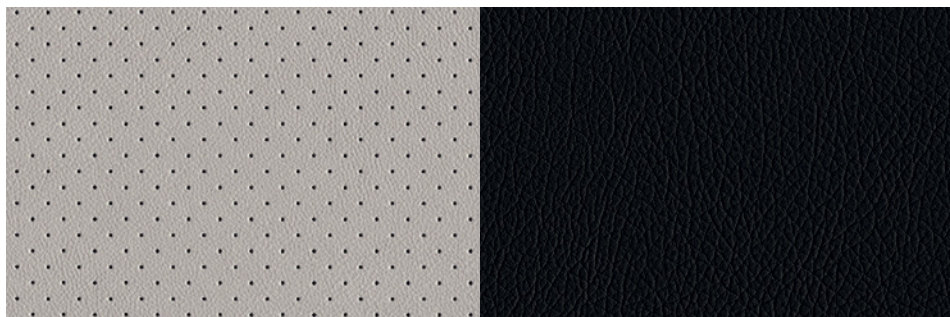

Upholstery in mahogany brown/silk beige

524 Exclusive nappa leather

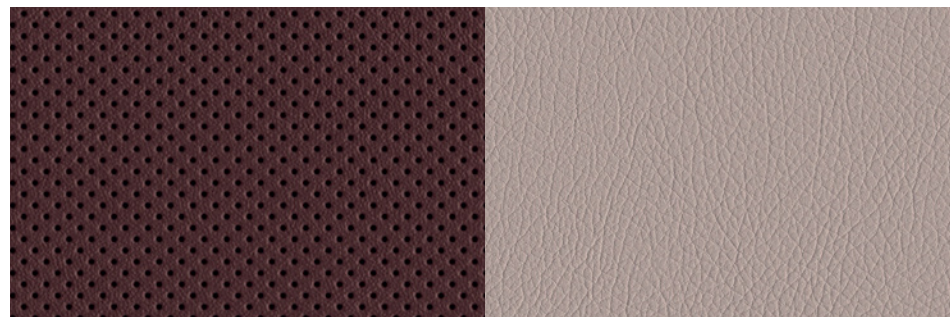

designo customizations - Upholstery.

Upholstery in mahogany brown/silk beige

524 Exclusive nappa leather

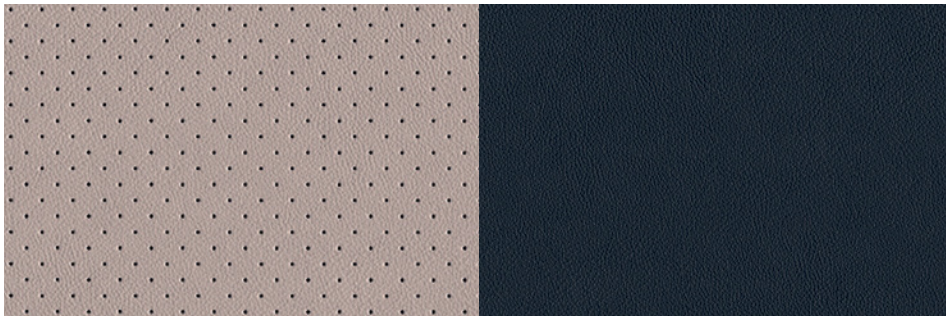

Upholstery in designo interior silk beige/titanium grey pearl

965 *designo* Exclusive semi-aniline leather

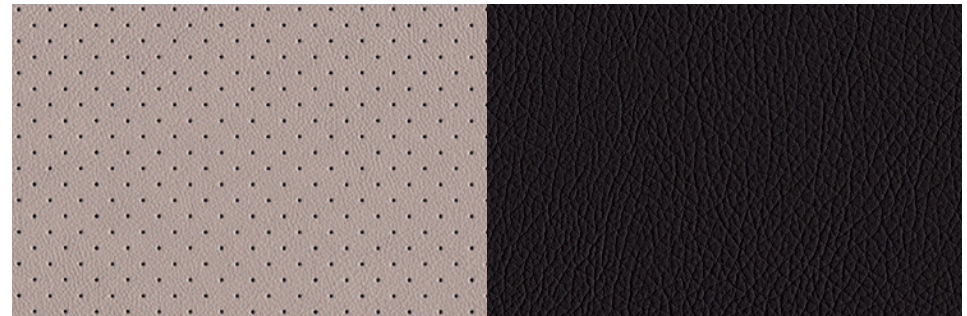

designo customizations - Trim.

Trim

H29 Burr walnut in high-gloss brown



729 Poplar wood in high-gloss black

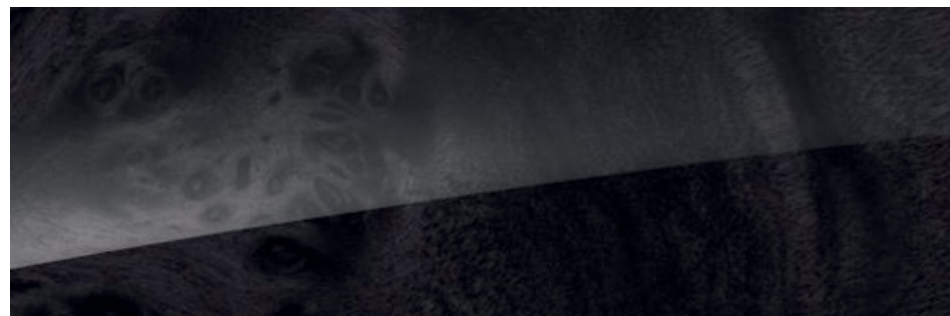

designo customizations - Trim.

Trim

H16 *designo* piano lacquer flowing lines in black (Standard for S 560)

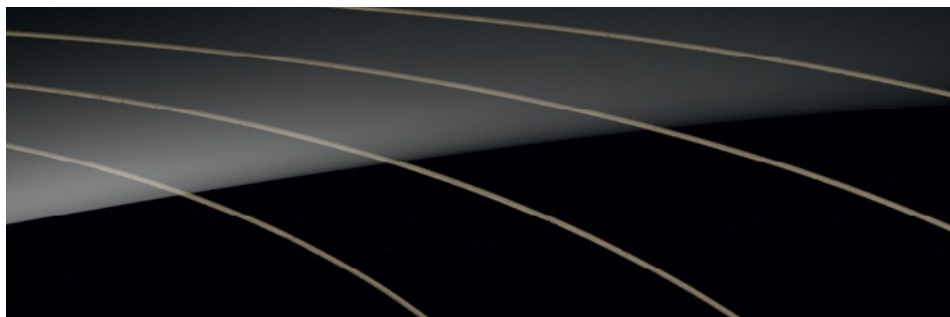

H21 *designo* piano lacquer in black

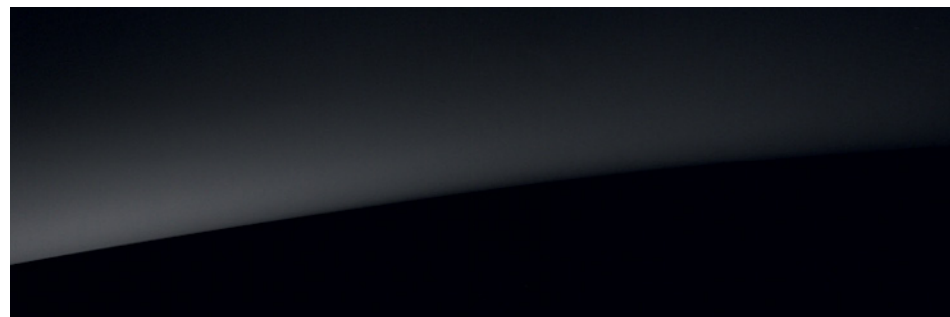

designo customizations - Paintwork.

designo paints

799 *designo* diamond white bright



designo paint finishes

033 *designo* mocha black metallic

044 *designo* allanite grey magno

049 *designo* cashmere white magno



designo customizations - Paintwork.

Metallic paints

183	magnetite black
197	obsidian black
775	diamond silver



Metallic paints

890	cavansite blue
897	ruby black
992	selenite grey



Metallic paints

989	emerald green
998	anthracite blue



designo Customizations - Wheels.

We have reinvented the car and perfected the wheel. You will find it all the easier to find a wheel befitting your new Mercedes-Maybach S-Class. Make your choice from this inspiring selection.



R17
5-twin-spoke light alloy wheels featuring a high sheen finish, with 245/45 R 19 tyres at the front and 275/40 R 19 tyres at the rear (Standard for S 560)



11R
Multi-spoke light alloy wheels, vanadium silver, with 245/45 R 19 tyres at the front and 275/40 R 19 tyres at the rear (ex-factory accessory wheel; Standard for S 650)



12R
7-triple-spoke light alloy wheels, vanadium silver, with 245/45 R 19 tyres at the front and 275/40 R 19 tyres at the rear (Optional for S 650)



R91
Maybach forged wheels with 10-hole trim, ceramic high-gloss polished finish, including fully integrated wheel bolt covers, with 245/40 R 20 tyres at the front and 275/35 R 20 tyres at the rear (Optional for S 650)



17R
Maybach forged wheels with 20-hole trim, bicolor, painted and polished, including fully integrated wheel bolt covers, with 245/40 R 20 tyres at the front and 275/35 R 20 tyres at the rear (Optional for S 650)



R28
Multi-spoke Maybach forged wheels, ceramic high-gloss polished finish, including fully integrated wheel bolt covers, with 245/40 R 20 tyres at the front and 275/35 R 20 tyres at the rear (Optional for S 650)

designo Customizations - Wheels.



5-spoke light-alloy wheels, painted in thulium silver, with 245/40 R 20 tyres at the front and 275/35 R 20 tyres at the rear (Optional for S 650)



5-twin-spoke light alloy wheels, painted in thulium silver, with 245/40 R 20 tyres at the front and 275/35 R 20 tyres at the rear (Optional for S 650)



Multi-spoke light alloy wheels, painted in thulium silver, with 245/40 R 20 tyres at the front and 275/35 R 20 tyres at the rear (Optional for S 650)

Technical data.

	Mercedes-Maybach S 560	Mercedes-Maybach S 650
Arrangement/number of cylinders	V/8	V/12
Displacement (cc)	3982	5980
Rated output (kW (hp) at rpm)	345 (469)/5250-5500	463 (630)/5000
Rated torque (Nm at rpm)	700/2000-4000	1000/2300-4300
Transmission	9G-TRONIC	7G-TRONIC PLUS
Acceleration 1-100 km/s (s)	4.9	4.7
Top speed (km/h)	250	250
Tyres/wheels - front	245/45 R 19	245/45 R 19
Tyres/wheels - rear	275/40 R 19	275/40 R 19
Fuel tank capacity (optional)/incl. reserve of (l)	80 (-)/8.0	80 (-)/8.0
Luggage compartment capacity ⁷ (VDA) (l)	500	500
Kerb weight/payload (kg)	2245/570	2360/460
Permissible gross vehicle weight (kg)	2815	2820

Dimensions - Mercedes-Maybach S-Class.

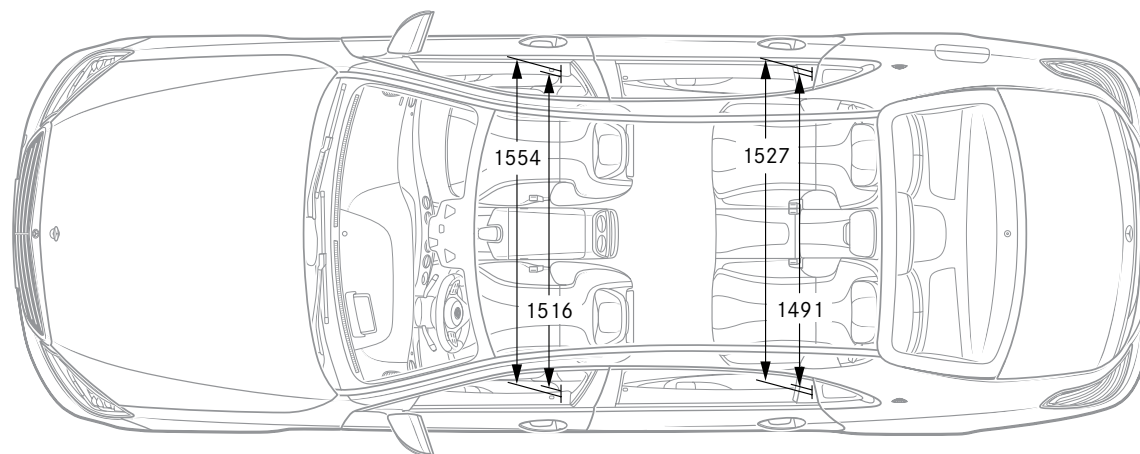
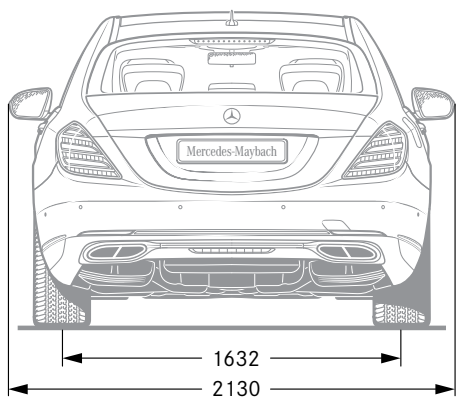
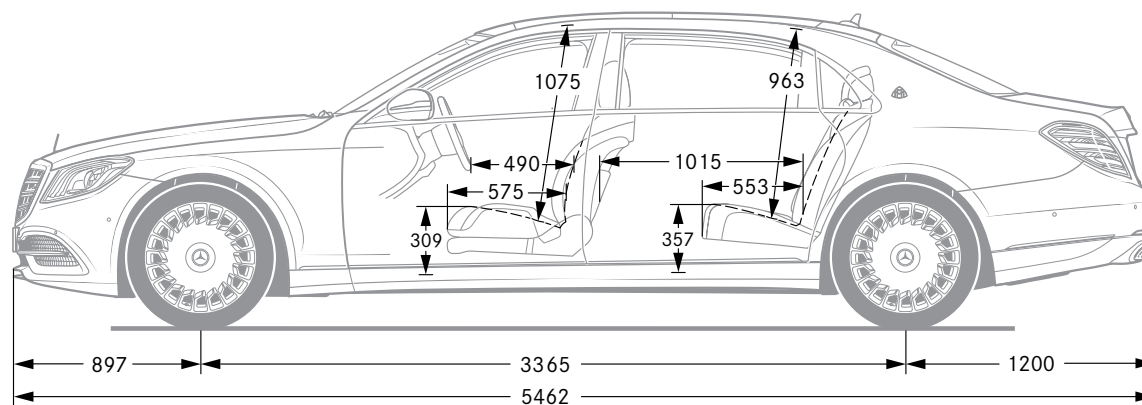
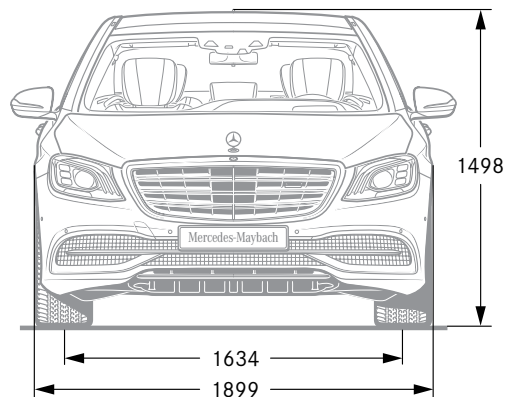

All dimensions in millimetres. The dimensions shown are mean values and apply to standard-specification, unladen vehicles.

*Please read the disclaimer.

My Mercedes. My Service.

You enjoy life. We'll take care of your Mercedes.

The best or nothing! This statement conveys how Mercedes-Benz aspires to develop and build highly desirable, top-class vehicles. The same passion, pledge and commitment apply to the Mercedes-Benz Service too. The bouquet of world-class After-Sales products will not only attend to every need of your Star but will also redefine the concept of ownership experience with a focus on providing end-to-end customer delight. After all, your Star deserves nothing less than the best.

STAR EASE

Delivering the best-in-class value

Servicing your Star does not get any better than this. With the STAR Ease Maintenance Packages, pay a defined cost of maintenance based on the model, contract period and mileage and say goodbye to spending on service every time. Plus, enjoy exclusive features like priority handling, shorter waiting time and quicker processes.

Advance Assurance Program

Extending your warranty coverage

With Advance Assurance Program, experience complete peace of mind. While this Extended Warranty Program kicks in the moment your standard 3 years warranty comes to an end, it can be extended further up to 6 years at a nominal price. Also, it comes with a bouquet of privileges for a worry-free time with your Star.

MOBILO

Providing you 24x7 mobility support

Your vehicle comes with Mobilo which provides round-the-clock on-road assistance service. Mobilo comes as a standard for 3 years and can be extended further up to 8 years at a nominal cost. This service offers privileges like vehicle towing facility, replacement vehicle, hotel accommodation, just to name a few.



My Mercedes. My Service.

Digital Service Drive

Ensuring convenience and transparency of service.

Servicing your Star is the last thing you will ever have to worry about. We provide transparent, convenient and hassle-free service. Our customer-friendly service features work around your busy schedule so that you have one less thing to focus upon.

Now booking your appointment is quick and easy.

To book your online service appointment, visit <http://mb4.me/SelectDealer>

Premier Express*

Because we value your time as much as you do.

Life gets busy and so we have designed Premier Express, our vehicle care service to help you get in and out quickly. While the visit will be brief, the service offered by our technicians will be comprehensive and complete. All to ensure your Mercedes-Benz is running for miles to come.

*Available at select locations only



*Please read the disclaimer.

My Mercedes. My Service.

Mercedes-Benz Genuine Parts Now with 2 years* of warranty

Mercedes-Benz Genuine Parts are crafted to the state-of-the-art standards of Mercedes-Benz, protecting your vehicle's performance while maintaining the style, comfort and safety, for the years to come. Also, they come with a warranty of up to 2 years, ensuring you a peaceful ownership experience with your Star.

* Terms & Conditions Apply



Mercedes-Benz Approved Tyres and Rims Ensuring every ride is a safe and joyful one

Maximise the safety and comfort of your Star with Mercedes-Benz approved tyres and rims. While the Mercedes-Benz approved tyres are designed to optimally match your car's performance, the Mercedes-Benz approved rims are designed to lend an exceptional style to the exterior of your Star and are also engineered for optimal performance.



Mercedes-Benz Genuine Chemical Products Because your Star deserves nothing but the original

Mercedes-Benz Genuine Chemical Products are specially tested for compatibility with the materials in our cars and meet the high quality standards. Also, our products have been approved under Daimler AG's strict, self-imposed environmental norms. Now with Mercedes-Benz Genuine Chemical Products, experience a whole new world of superior products that support throughout the car's life cycle.



*Please read the disclaimer.

Mercedes-Benz India Private Limited: E-3, MIDC Chakan - Phase III, Chakan Industrial Area, Kuruli & Nighoje, Tal: Khed, Pune - 410 501 (India)
Toll free No.: 0008000501888. e-mail: cs.ind@cac.mercedes-benz.com, **website: www.mercedes-benz.co.in**

Please note: This brochure is intended for general information, description and illustration of the Product including optional functions and equipment and may not be specific to a Product since specification of a product may change from time to time. Optional features, functions and equipment etc. may not be present in the Standard or Variant Product or Special Edition Product. Further, Standard specifications of a product may also vary from time to time. Colours may differ from those shown in pictures in the brochure, owing to printing. Mercedes-Benz India reserves the right to make changes, at any point of time, without prior notice, in design, colours, materials, components, equipment, specifications, features, functions, make and models etc. The information given in this brochure shall be regarded as accurate at the time of going to print and may vary thereafter due to any developments or any other reason. Interested parties should confirm with the Authorised Dealer about the correct specification of the product they desire to purchase. For the latest authentic information and updates, kindly contact your nearest Authorised Dealer.

All title, ownership rights and intellectual property rights in and relating to this brochure / magazine or publication material or any copies thereof including but not limited to copyright, logos, names, trademarks, service marks, design, text, images, links, concepts and themes are owned by Daimler AG and/or its subsidiaries collectively or used under authorised license by the Daimler AG. Any reproduction, transmission, publication, performance, broadcast, alteration, license, creation of derivative works or other use in whole or in part in any manner without the prior written consent of the Daimler AG is strictly prohibited.

Mercedes-Benz cars: The Mercedes-Maybach S-Class meets Bharat Stage VI equivalent emission norms.

CIN - U34102PN1994PTC083160